

# 2000 SERIES® RACEWAY



Two-piece, single-channel raceway. Easy-to-install and ideal for basic power or communication/low voltage installations

## CODE REFERENCE

**cULus Listed Raceway:**  
File E4376 Guide RJBT.

**Fittings:**  
File E41751 Guide RJPR.  
Meets Article 386 of NEC.  
Meets Section 12-1600 of CEC.

## System Layout

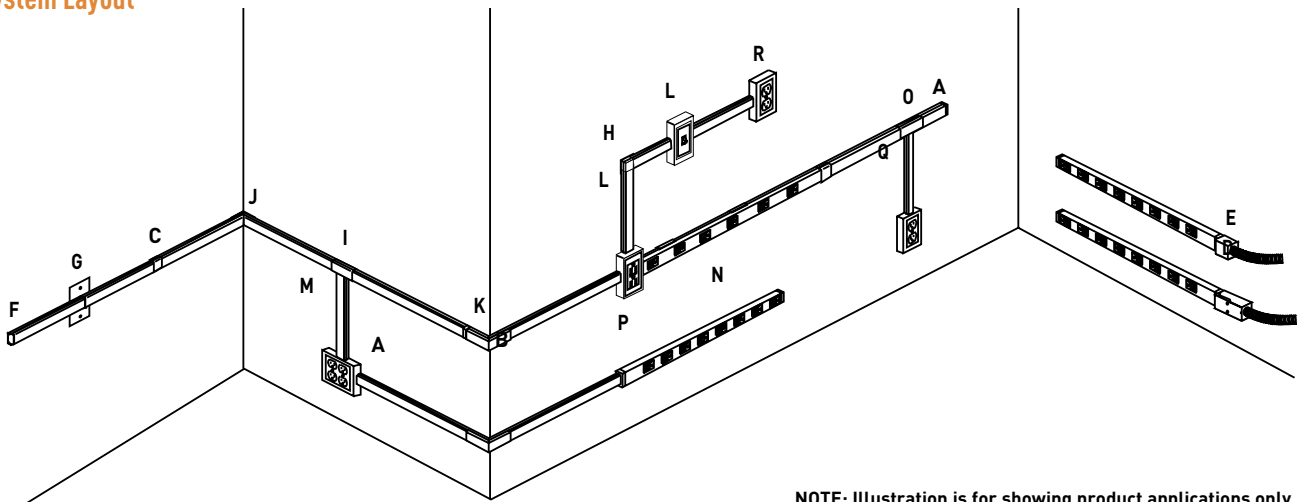

**NOTE:** Illustration is for showing product applications only.

## KEY

- |                                |                                    |                                 |
|--------------------------------|------------------------------------|---------------------------------|
| A. 500 Series Raceway          | G. 2051H Flush Plate Adapter       | M. 2048-2 Two-Gang Device Box   |
| B. 518 External Elbow Fitting  | H. 2011 90° Flat Elbow Fitting     | N. 20GB506 Plugmold Strip       |
| C. 2006 Cover Clip             | I. 2015 Tee Fitting                | O. 2089A Flush Plate Adapter    |
| D. 2010A3 Entrance End Fitting | J. 2017TC Internal Corner Coupling | P. 2089E End-Reducing Connector |
| E. 2010A2 Entrance End Fitting | K. 2018C External Elbow Cover      | Q. 5748 Single-Gang Device Box  |
| F. 2010B Blank End Fitting     | L. 2048 Single-Gang Device Box     |                                 |

## COLOR OPTIONS



2000® Series Raceway Part Numbers with a "V" prefix have an ivory finish. Part Numbers with a "G" prefix have a gray finish. Part Numbers without a prefix or suffix have a protective zinc finish.

**Custom color options are also available. Consult the factory for more information.**

# 2000 SERIES® RACEWAY

## 2000 Series Raceway Interconnectivity Fittings

CONNECTION REQUIRED		USE CATALOG NUMBER
FROM	TO	
500 Series Raceway	Side of 2000 Series Raceway	V2089, V2048, V2048-2
500 Series Raceway	End of 2000 Series Raceway	V2089E, V2048, V2048-2
Existing Outlet	2000 Series Raceway	V2051H
1/2" trade size Conduit or Armored Cable	2000 Series Raceway	V2010A2, V2010A3

### Blank End Fitting

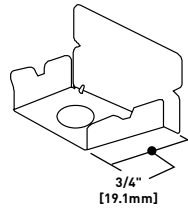

**PART NUMBERS:**  
**V2010B** (Ivory)  
**G2010B** (Gray)

Closes off the open end of 2000 Series Raceway.

## 2000 Series Raceway Ordering Information (continued)

### Cover Clip

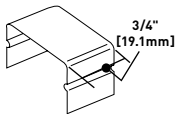

**PART NUMBERS:**  
**V2006** (Ivory)  
**G2006** (Gray)

Covers seam where two lengths of 2000 Series Raceway come together.

### Flat Elbow Fitting

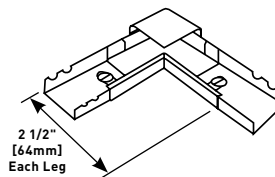

**PART NUMBERS:**  
**V2011** (Ivory)  
**G2011** (Gray)

For right angle turns on same surface. Cover stop permits neat butting of 2000C Cover. Two couplings included.

### 2009 Ground Clamp

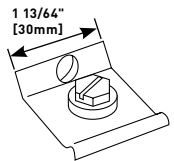

Connects equipment grounding conductor. Provides an additional ground for raceway.

How 2009 is used.

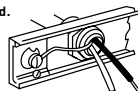

### Tee Fitting

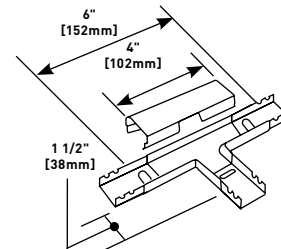

**PART NUMBERS:**  
**V2015** (Ivory)  
**G2015** (Gray)

For branching raceway at right angles. Three couplings included.

### Entrance End Fitting

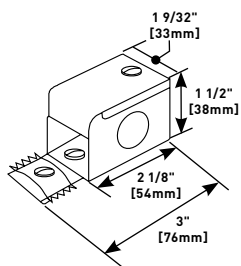

**PART NUMBERS:**  
**V2010A2** (Ivory)  
**G2010A2** (Gray)

Connects 2000 Series Raceway to 1/2" trade size conduit or armored cable connectors. 1/2" trade size KOs located on end, sides, and bottom of fitting. Includes ground screw. If more capacity is required, use 2010A3.

### 2017TC Internal Corner Coupling

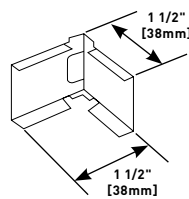

Can be used as inside corner coupling or as coupling and straight thru fitting. Furnished with one fiber bushing.

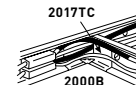
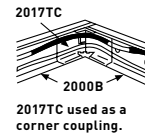

2017TC used as a corner coupling.

2017TC used as a corner coupling and a straight-through fitting.

### Entrance End Fitting

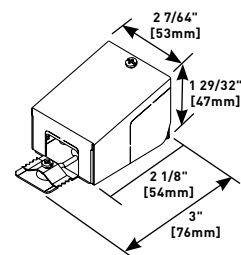

**PART NUMBERS:**  
**V2010A3** (Ivory)  
**G2010A3** (Gray)

1/2" trade size KOs located on end, sides, and bottom of fitting. 3/4" KOs on bottom and rear. Includes ground screw.

### External Elbow Cover

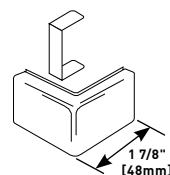

**PART NUMBERS:**  
**V2018C** (Ivory)  
**G2018C** (Gray)

Covers gap when external corner is made by notching and bending 2000B Base. Continues raceway runs around outside corners.

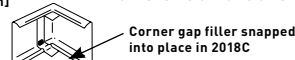

Corner gap filler snapped into place in 2018C

# PLUGMOLD® 2000 SERIES™



Two-piece, low profile multiple outlet raceway. Low profile requires minimal space.

## CODE REFERENCE

**cULus Listed Base & Blank Cover:**  
File E4376 Guide RJBT.

**Multi-Outlet Assemblies:**  
File E15191 Guide PVGT.

**Fittings:**  
File E41751 Guide RJPR.

**Base & Blank Cover & Plugmold Series with Snapicoil Harness:**  
Meets Article 386 of NEC.  
Meets Section 12-3032 of CEC.

**Plugmold Wired Sections:**  
Meets Article 380 of NEC.  
Meets Section 12-3032 of CEC.

## Plugmold 2000 Series System Layout

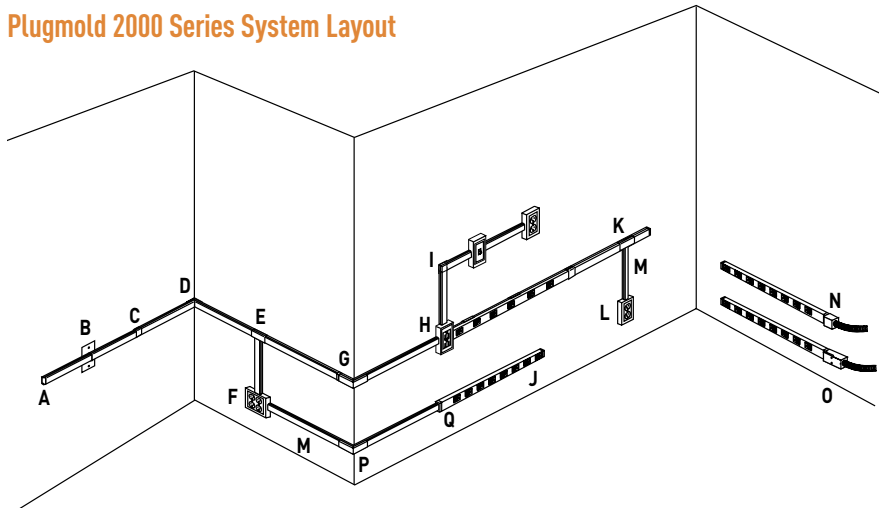

**NOTE:** Illustration is for showing product applications only.

## KEY

- A. V2010B Blank End Fitting
- B. V2051H Flush Plate Adapter
- C. V2006 Cover Clip
- D. 2017TC Internal Corner Coupling
- E. V2015 Tee Fitting
- F. V2048-2 Two-Gang Device Box
- G. V2018C Extern Elbow Cover
- H. V2048 Single-Gang Device Box
- I. V2011 90° Flat Elbow
- J. V20GB506 Plugmold Strip
- K. V2089 Side-Reducing Fitting
- L. V5748 Single-Gang Device Box
- M. V500 500 Series Raceway
- N. V2010A2 Entrance End Fitting
- O. V2010A3 Entrance End Fitting
- P. V518 External Elbow
- Q. V2089E End-Reducing Connector

## COLOR OPTIONS



Plugmold® 2000 Series™ Part Numbers with a "V" prefix have an ivory finish. Part Numbers with a "G" prefix have a gray finish. Part Numbers with a "S" prefix have a stainless finish. Part Numbers with a "WH" prefix have a white finish. Part Numbers with a "BK" prefix have a black finish. Part Numbers without a prefix have a galvanized steel finish unless otherwise specified.

**Custom color options are also available. Consult the factory for more information.**

# PLUGMOLD® 2000 SERIES™

## Plugmold 2000 Series Ordering Information (continued)

### 2009 Ground Clamp (Galvanized)

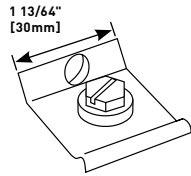

Connects equipment grounding conductor to provide an additional ground to raceway.

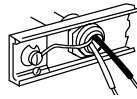

How 2009 is used.

### Entrance End Fitting

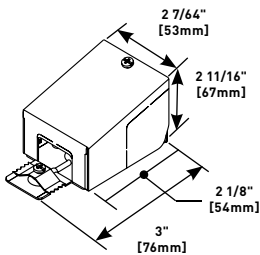

**PART NUMBERS:**  
**V2010A3** (Ivory)  
**WH2010A3** (White)  
**G2010A3** (Gray)  
**BK2010A3** (Black)

Offers larger capacity than V2010A2. 1/2" trade size KOs on end, each side and bottom. 3/4" trade size KOs on bottom and rear. Includes ground screw.

### 2010A2 Entrance End Fitting

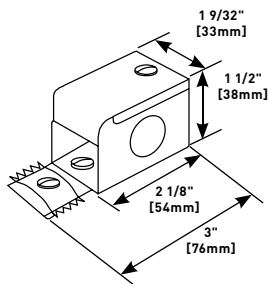

Connects 2000 Series Raceway with 1/2" trade size conduit and armored cable connectors. 1/2" trade size KOs on end, each side and bottom. Includes ground screw.

### Blank End

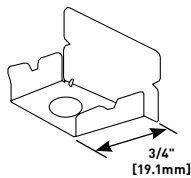

**PART NUMBERS:**  
**V2010B** (Ivory)  
**WH22010B** (White)  
**G2010B** (Gray)  
**BK2010B** (Black)  
**S2010B** (Stainless Steel)

Closes off open end of 2000 Series Raceway.

### 90° Flat Elbow

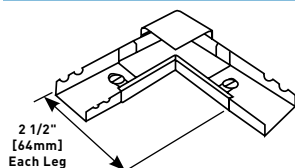

**PART NUMBERS:**  
**V2011** (Ivory)  
**WH2011** (White)  
**G2011** (Gray)  
**BK2011** (Black)  
**S2011** (Stainless Steel)

Right angle turns on same surface. Cover stop permits neat butting of 2000C Cover. Two couplings furnished.

### Tee

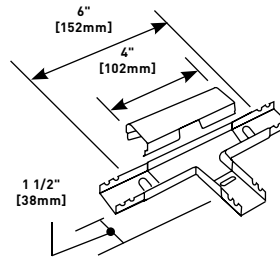

**PART NUMBERS:**  
**V2015** (Ivory)  
**WH2015** (White)  
**G2015** (Gray)  
**BK2015** (Black)

Branches raceway at right angles. Couplings furnished.

### 2017TC Internal Corner Coupling

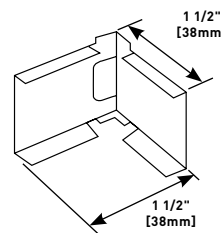

Furnished with one fiber bushing.

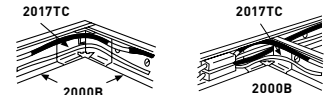

- 2017TC used as a corner coupling.
- 2017TC used as a corner coupling and a straight-through fitting.

### External Elbow Cover

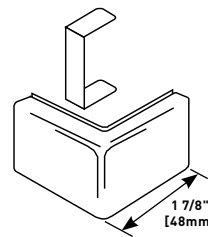

**PART NUMBERS:**  
**V2018C** (Ivory)  
**WH2018C** (White)  
**G2018C** (Gray)  
**BK2018C** (Black)  
**S2018C** (Stainless Steel)

Continues raceway runs around outside corner. Fills the gap when external corner is made by notching and bending the 2000 Base.

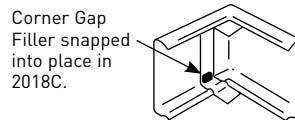

Corner Gap Filler snapped into place in 2018C.

### Single-Gang Device Box

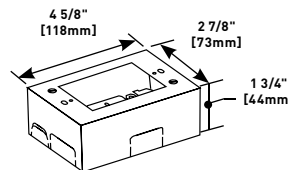

**PART NUMBERS:**  
**V2048** (Ivory)  
**WH2048** (White)  
**G2048** (Gray)  
**BK2048** (Black)  
**S2048** (Stainless Steel)

Cover has twistouts for 2000, 500 and 700 Series Raceways. Base has 1/2" trade size KO and rectangular KO for extension to wall box. Base has No. 10 threaded hole for ground connection.

# PLUGMOLD® 2000TR SERIES™

## Steel Plugmold 2000TR Series Ordering Information (continued)

### 2001 Coupling

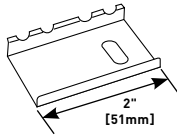

Joins lengths of Plugmold 2000TR Series together.

### V2051H Back Feed Fitting

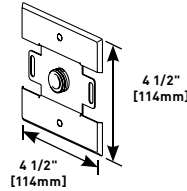

Feeds Plugmold 2000TR Series from an existing outlet box. Equipped with 1/2" trade size male bushing and lock nut washer for grounding.

### 2009 Ground Clamp

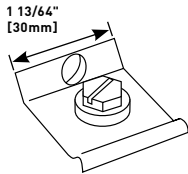

Connects equipment grounding conductor to Plugmold 2000TR Series.

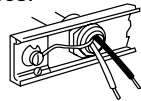

How 2009 is used.

### Entrance End Fitting

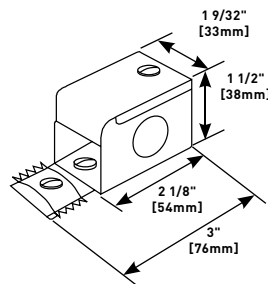

**PART NUMBERS:**  
**V2010A2** (Ivory)  
**WH2010A2** (White)  
**G2010A2** (Gray)  
**BK2010A2** (Black)  
**S2010A2** (Stainless Steel)

Connects Plugmold 2000TR Series with 1/2" trade size conduit and armored cable connectors. 1/2" trade size KOs on end, each side and bottom. Includes ground screw.

### Blank End Fitting

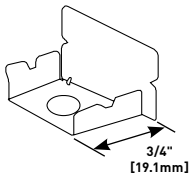

**PART NUMBERS:**  
**V2010B** (Ivory)  
**WH2010B** (White)  
**G2010B** (Gray)  
**BK2010B** (Black)  
**S2010B** (Stainless Steel)

Closes off open end of sections of Plugmold 2000TR Series.

### Entrance End Fitting

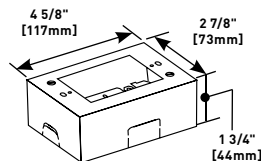

**PART NUMBERS:**  
**V2040B** (Ivory)  
**WH2040B** (White)  
**G2040B** (Gray)  
**BK2040B** (Black)  
**S2040B** (Stainless Steel)

One-gang device box. Cover has one twistout for 2000 Series Plugmold on two sides and one twistout for 500® and 700® Series Raceway on the top and bottom. Base includes knockout to enable extension from existing single-gang flush wall box and 1/2" trade size KOs. Accepts industry standard faceplates for electrical and communication devices.