

## CONDENSING TANKLESS GAS WATER HEATER

# Owner's Guide

Models : NRC98DV (GQ-C2857WS-FF US)  
NRC98OD (GQ-C2857WS US)

FOR USE IN RESIDENTIAL OR MANUFACTURED HOME APPLICATIONS.



### WARNING

If the information in this manual is not followed exactly, a fire or explosion may result causing property damage, personal injury, or death.

- Do not store or use gasoline or other flammable vapors and liquids in the vicinity of this or any other appliance.
- WHAT TO DO IF YOU SMELL GAS
  - Do not try to light any appliance.
  - Do not touch any electrical switch; do not use any phone in your building.
  - Immediately call your gas supplier from a neighbor's phone. Follow the gas supplier's instructions.
  - If you cannot reach your gas supplier, call the fire department.
- Installation and service must be performed by a qualified installer, service agency or the gas supplier.



Low NOx Approved  
by SCAQMD  
14 ng/J or 20 ppm  
(Natural Gas Only)



Thank you for purchasing this Noritz Tankless Gas Water Heater. Before using, please:

Read this manual completely for operation instructions. Completely fill out the warranty registration card (included separately) and mail the detachable portion to Noritz America Corporation. Keep this manual (and the remainder of the warranty registration card) where it can be found whenever necessary.

Installation must conform with local codes, or in the absence of local codes, the National Fuel Gas Code, ANSI Z223.1/NFPA 54 - latest edition and/or the Natural Gas and Propane Installation Code CSA B149.1 - latest edition.

When applicable, installation must conform with the Manufactured Home Construction and Safety Standard, Title 24 CFR, Part 3280 or the Canadian Standard CAN/CSA-Z240 MH Mobile Homes, Series M86. Noritz America reserves the right to discontinue, or change at any time, the designs and/or specifications of its products without notice.

## NORITZ America Corporation





# Important Safety Information-1

To prevent damage to property and injury to the user, the icons shown below will be used to warn of varying levels of danger. Every indication is critical to the safe operation of the water heater and must be understood and observed. Potential dangers from accidents during installation and use are divided into the following four categories. Closely observe these warnings; they are critical to your safety.

## ■ Icons warning of risk level

 This is the safety alert symbol. It is used to alert you to potential personal injury hazards. Obey all safety messages that follow this symbol to avoid possible injury or death.

	<b>DANGER</b>	DANGER indicates an imminently hazardous situation which, if not avoided, will result in death or serious injury.
	<b>WARNING</b>	WARNING indicates a potentially hazardous situation which, if not avoided, could result in death or serious injury.
	<b>CAUTION</b>	CAUTION indicates a potentially hazardous situation which, if not avoided, may result in minor or moderate injury.
<b>CAUTION</b>		CAUTION used without the safety alert symbol indicates a potentially hazardous situation which, if not avoided, may result in property damage.

## ■ Other icons

 Electric Shock.	 High Temperature.	 Be sure to do.	 Ground.	
 Prohibited	 No flame.	 Don't touch.	 Don't disassemble the equipment.	 Don't touch with a wet hand.

## DANGER



Prohibited

**Vapors from flammable liquids will explode and catch fire causing death or severe burns.**

Do not use or store flammable products such as gasoline, solvents or adhesives in the same room or area near the water heater.

**Keep flammable products:**

1. Far away from the water heater.
2. In approved containers.
3. Tightly closed.
4. Out of children's reach.

**Vapors:**

1. Cannot be seen.
2. Vapors are heavier than air.
3. Go a long way on the floor.
4. Can be carried from other rooms to the main burner by air currents.



Prohibited

**Hot Water Heater temperatures over 125°F (52°C) can cause severe burns instantly or death from scalding.**

Children, disabled and elderly are at the highest risk of being scalded. Feel water temperature before bathing or showering. Temperature limiting valves are available, ask professional person.

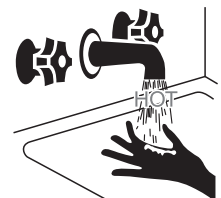

(Continued)



Prohibited

**[NRC98DV]**

Do not use the water heater if the intake/exhaust pipe is displaced, has holes, is clogged or is corroded.

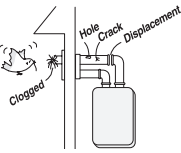

Prohibited

**[NRC98OD]**

**Do Not Install Indoors.**

This will cause carbon monoxide poisoning and a potential fire hazard.

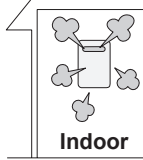

Prohibited

Do not allow anyone to change the water temperature while hot water is being used.

To prevent scalding, do not change the water temperature to a higher setting.



Be sure to do.

**[When supplying combustion air from the indoors]**

Check whether or not the air supply vent is blocked with dust, trash, a towel, or the like.

Blocking the opening may result in incomplete combustion.

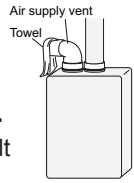

Be sure to do.

After the water heater has been out of use for a long time make sure that you fill the condensate trap with water.

This is to prevent dangerous exhaust gases from entering the building.

Failure to fill the condensate trap could result in severe personal injury or death. (Refer to page 20 for further instructions.)

## **WARNING**



No flame.

**A. This water heater does not have a pilot. It is equipped with an ignition device that automatically lights the burner. Do not try to light the burner by hand.**

**B. BEFORE OPERATING** smell all around the water heater area for evidence of leaking gas. Be sure to smell next to the floor because some gas is heavier than air and will settle on the floor.

**WHAT TO DO IF YOU SMELL GAS.**

- Do not try to light any appliance.
- Do not touch any electrical switch; do not use any phone in your building.
- Immediately call your gas supplier from a neighbor's phone. Follow the gas supplier's instructions.
- If you cannot reach your gas supplier, call the fire department.

**C. Use only your hand to turn the gas valve knob. Never use tools. If the knob will not turn by hand, don't try to repair it. Call a qualified service technician. Force or attempted repair may result in a fire or explosion.**

**D. Do not use this water heater if any part has been under water. Immediately call a qualified service technician to inspect the water heater and to replace any damaged parts.**



Be sure to do.

**When a gas leak is noticed:**

1. Stop use immediately
2. Close the gas valve [NRC98DV]
3. Open windows and doors



Be sure to do.

**If you detect abnormal combustion or abnormal odors, or during an earthquake, tornado or fire:**

1. Turn off the hot water supply
2. Turn off the power to the water heater
3. Turn off gas and water supply valve.
4. Call the nearest Noritz agent



Prohibited

**Explosion Hazard ;**

If the temperature and pressure relief valve is dripping or leaking, have a qualified service technician replace it. Do not plug or remove the valve.

Failure to follow these instructions can result in fire or explosion, and personal injury or death



High Temperature.

**Check the temperature of the running hot water before entering the shower.**



**Check the temperature before stepping into the bath tub.**



(Continued)

# Important Safety Information-2

(Continued)

## ⚠️ WARNING



**Do not place the exhaust vent terminal in an indoor environment by means of adding walls and ceiling (Do not enclose using corrugated sheets, etc.)**

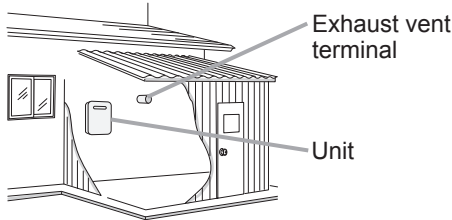

Carbon monoxide poisoning or fire may occur as a result.



**[NRC98DV] Do not place outdoors**

Rain may enter the unit or the burner fire may be blown by the wind, causing malfunction or fire as a result.



**Leave the proper clearance between the water heater and nearby objects (trees, timber, boxes with flammable materials etc.).**

**[NRC98DV]**

Upper: Min. 12" (300mm) Sug. 3" (75mm) from vent pipe\*

Left side: Min. 2" (50mm) Right side: Min. 2" (50mm)

Front: Sug. 24" (600mm)\*

**[NRC98OD]**

Upper: Min. 36" (900mm)

Left side: Min. 6" (150mm) Right side: Min. 6" (150mm)

Front: Sug. 24" (600mm)\*

\* Indicates suggested clearances for maintenance.



**Do not place combustibles such as laundry, newspapers, oils etc. near the heater or the exhaust vent terminal.**

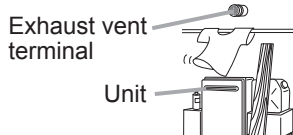

**Carbon Monoxide Poisoning Hazard. Do not install this water heater in a recreational vehicle or on a boat. Do not install this water heater in a mobile home when using SV conversion kit ("-SV" configuration).**



**Do not use combustible chemicals such as oil, gasoline, benzene etc. in the near the heater or the exhaust vent terminal.**



**Do not store or use gasoline or other flammable vapors and liquids in the vicinity of this or any other appliance.**



**Do not place or use a spray can near the water heater or the exhaust vent terminal.**



**Be sure the gas/power supplied matches the gas on the rating plate.**

Ex. For Natural Gas (NRC98DV (GQ-C2857WS-FF US))

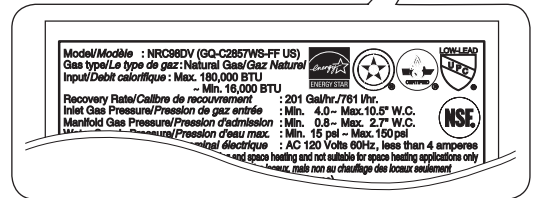
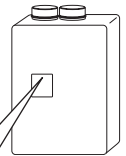

**Installation and service must be performed by a qualified installer, service agency or the gas supplier.**



**If this unit will be installed in a beauty salon or other location where hair spray or aerosols will be used, locate the unit in a separate area that is supplied with fresh air from outdoors.**



**Do not use hair spray or spray detergent in the vicinity of the heater.**



**[When supplying combustion air from the indoors]**

**Check the air supply opening for dust or obstructions.**



(Continued)

(Continued)



Prohibited

Do not allow small children to play unsupervised in the bathroom.  
Do not allow small children to bath unsupervised.



Don't touch with a wet hand.



Electric Shock.

Do not touch the power cord with wet hands.



Be sure to do.

Consult the nearest Noritz agent if the water heater location needs to be changed.



Don't disassemble the equipment.

Contact a qualified service technician for any necessary repairs, service or maintenance.



Be sure to do.

Contact Noritz before using with a solar pre-heater.

California Proposition 65 lists chemical substances known to the state to cause cancer, birth defects, death, serious illness or other reproductive harm. This product may contain such substances, be their origin from fuel combustion (gas, oil) or components of the product itself.

The gas conversion kit shall be installed by a qualified service agency in accordance with the manufacturer's instructions and all applicable codes and requirements of the authority having jurisdiction. The information in the instructions must be followed to minimize the risk of fire or explosion or to prevent property damage, personal injury, or death. The qualified service agency is responsible for the proper installation of this kit. The installation is not proper and complete until the operation of the converted appliance is checked as specified in the manufacturer's instructions supplied with the kit.



## CAUTION



Ground.

Be sure to electrically ground the unit.



Be sure to do.

Keep power cord free of dust.



Prohibited

Do not use the water heater for other than hot water supply, shower and bath.



Prohibited

Do not use a broken or modified power cord. Do not bind, bend or stretch power cords. Do not scratch, modify, or subject them to impact or force.



Be sure to do.

To prevent burns or scalding, turn off the power button and wait until the equipment cools before performing maintenance.



Prohibited

Do not turn off the water heater while someone is bathing.



Prohibited

Do not cover the water heater and the exhaust vent terminal, store trash or debris near it, or in any way block the flow of fresh air to the unit.



Prohibited

Do not install in locations where excessive dust or debris will be in the air.



Don't touch.

Do not touch the exhaust vent pipe and exhaust vent terminal during or immediately after operation of the water heater.

[NRC98DV]

[NRC98OD]

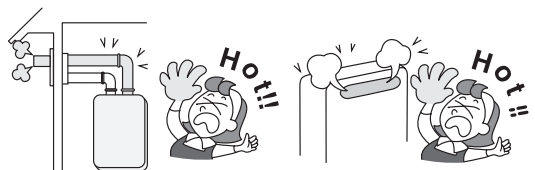

Prohibited

Do not use condensate, discharged from the drain pipe, for drinking or for consumption by animals.

# Important Safety Information-3

## CAUTION

**Do not drink water that has been inside the unit for an extended period of time. Do not drink the first use of hot water from the unit in the morning.**

---

**Clean the filter on the water inlet as frequently as required by the quality of your local water.**

---

**Keep the area around the unit clean.**

If boxes, weeds, cobwebs, cockroaches etc. are in the vicinity of the unit, damage or fire can result.

---

**Do not install the equipment where the exhaust will blow on walls or windows.**

---

**If the water supply is in excess of 12 grains per gallon (200 mg/L) of hardness, acidic or otherwise impure, treat the water with approved methods in order to ensure full warranty coverage. (→ p.23)**

---

**Problems resulting from scale formation are not covered by the warranty.**

---

**Check ignition during use and extinction after use.**

---

**Do not run water through the unit when unit is not on.**

When discharging hot water, make sure the unit is ON. If water is run through the unit with the unit OFF, water may condense inside the unit and cause incomplete combustion or damage to the internal electrical components.

For single-handle fixtures or valves, discharge water setting the handle completely to the water side.

**This unit is only approved for installation up to 4500 ft. (1350m) above sea level.**

For installations at higher elevations, contact Noritz America for Instructions.

---

**Do not disassemble the remote controller.**

**Do not use benzene, oil or fat detergents to clean the remote controller.**

This may cause deformation.

**Do not get the remote controller wet.**

Although it is water resistant, too much water can cause damage.

**Do not splash water on the remote controller. Do not expose the remote controller to steam.**

Do not locate the remote controller near stoves or ovens, this may cause damage or failure.

---

**Preventing damage from freezing (→ p.18)**

Damage can occur from frozen water within the device and pipes even in warm environments. Be sure to read below for appropriate measures. Repairs for damage caused by freezing are not covered by the warranty.

---

**Take necessary measures to prevent freezing of water and leakage of gas when leaving the unit unused for long periods of time. (→ p.19)**

---

**If it is snowing, check the exhaust vent terminal for blockage.**

---

**Do not use parts other than those specified for this equipment.**

# Contents

<b>Important Safety Information .....</b>	<b>2</b>
<b>Contents.....</b>	<b>7</b>
<b>Overview of Condensing Tankless Gas Water Heater .....</b>	<b>8</b>
<b>General Parts</b>	
<b>Main Unit.....</b>	<b>9</b>
<b>Remote Controller.....</b>	<b>10</b>
<b>Initial Operation.....</b>	<b>11</b>
<b>How to Use</b>	
<b>Setting and Using the Water Heater .....</b>	<b>12</b>
<b>Flow Meter Alarm .....</b>	<b>14</b>
<b>Muting the Remote Controller.....</b>	<b>16</b>
<b>Adjusting the Maximum Output Temperature .....</b>	<b>17</b>
<b>Preventing Damage from Freezing.....</b>	<b>18</b>
<b>Regular Maintenance .....</b>	<b>21</b>
<b>Troubleshooting .....</b>	<b>24</b>
<b>Follow-up Service .....</b>	<b>29</b>
<b>Specifications.....</b>	<b>31</b>

# Overview of Condensing Tankless Gas Water Heater

This water heater is a high efficiency, fully condensing appliance. Unlike a traditional tankless water heater, a condensing type captures heat from the exhaust gas and uses it to preheat the incoming cold water as it passes through the secondary heat exchanger as illustrated below.

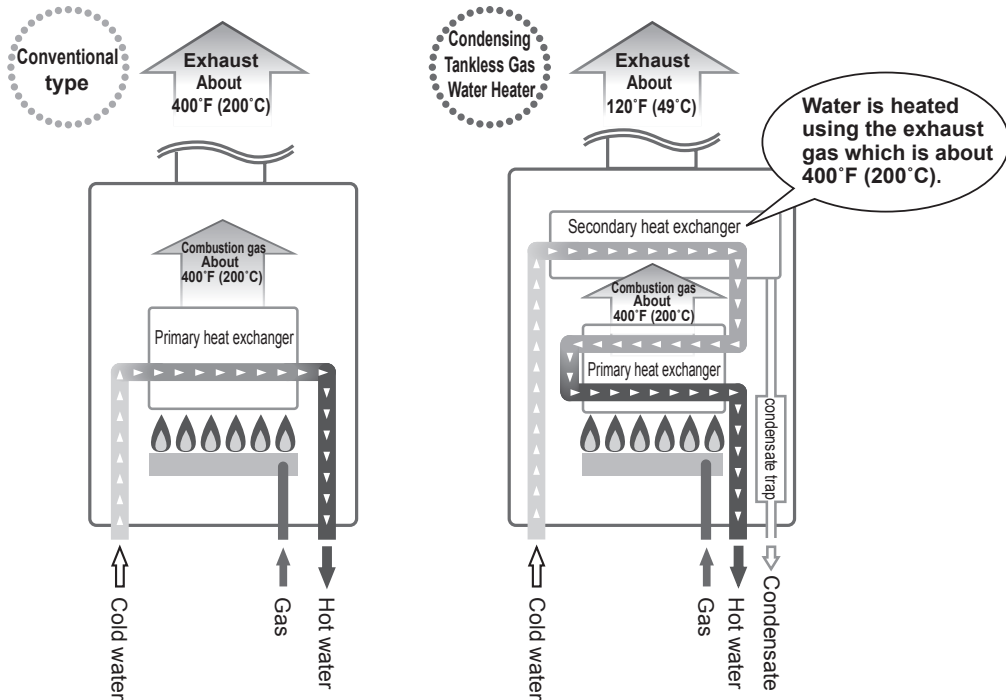

## The condensing tankless gas water heater discharges condensate.

When heat from the exhaust gas is collected within the secondary heat exchanger, condensation occurs from moisture in the exhaust gas and the resulting water is discharged from the drain pipe (approx. 2 gallons/hour (7.5 liters/hour) maximum). It is not a water leak. Do not plug or block the drain line as it must always be allowed to freely flow.

Note : The condensate discharged is acidic with a pH level of approximately 2-3.

A condensate neutralizer may be required by local code prior to disposal.

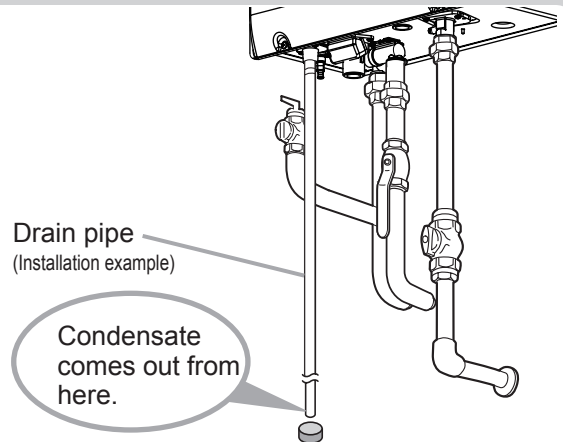

## The condensing tankless gas water heater tends to show white steam.

After the exhaust gas passes through the secondary heat exchanger, it becomes low in temperature and moisture rich which tends to produce steam at the vent discharge terminal. This is a normal occurrence.

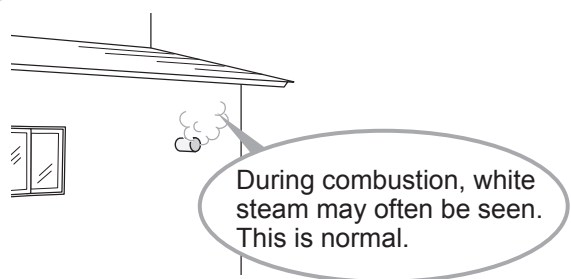



# General Parts -1

## Main Unit

[NRC98DV (GQ-C2857WS-FF US)]  
Indoor Wall Mounted, Power Vent/Sealed Model

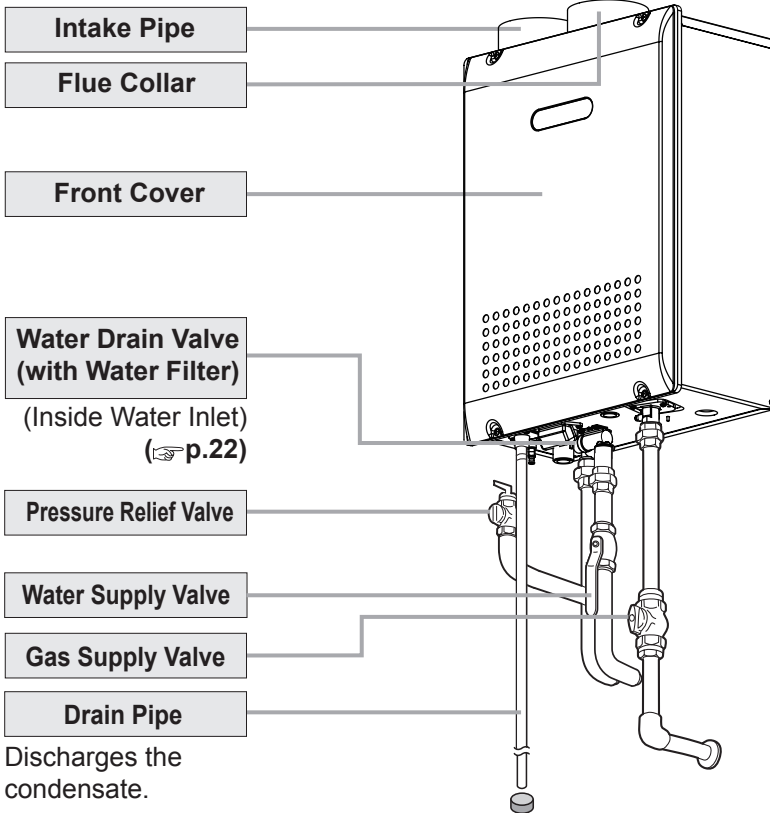

[NRC98OD (GQ-C2857WS US)]  
Outdoor Wall Mounted, Power Vented Model

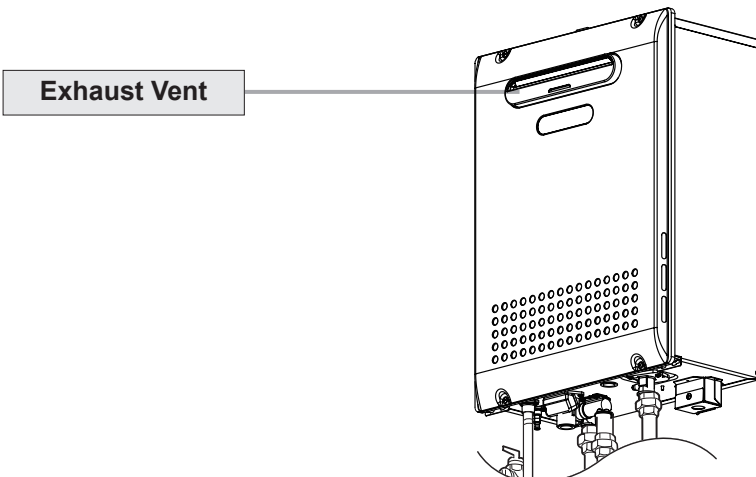

\* The above illustration shows an example of installation.  
The exact installation configuration may be slightly different.

# General Parts -2

## Remote Controller (RC-7651M)

What is actually displayed depends on how the water heater is set.

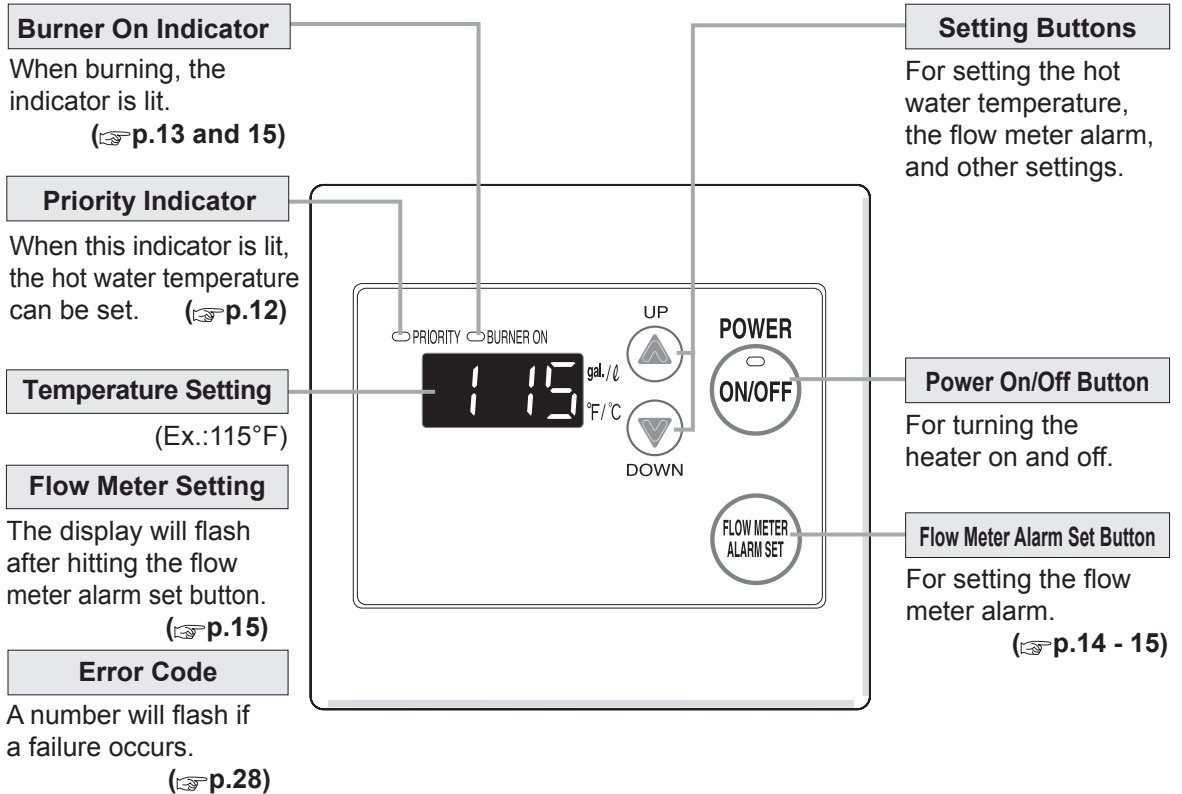

\* Before use, remove the protective sheet from the remote controller surface.

Note: As shipped from the factory, the remote controller is set to display in °F and gallons.  
To adjust the display to °C and liters, refer to the Installation Manual.

# Initial Operation

Before the first use of your water heater, make the following preparations.

Follow steps **1 through 4**.

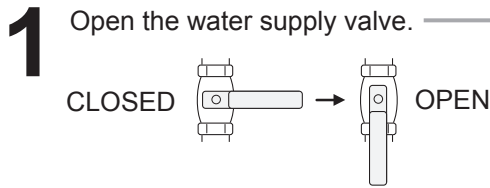

**2** Open a hot water fixture to confirm that water is available, and then close the fixture again.

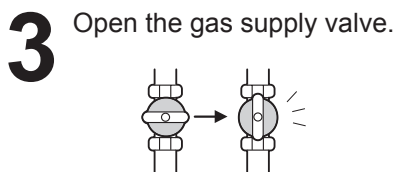
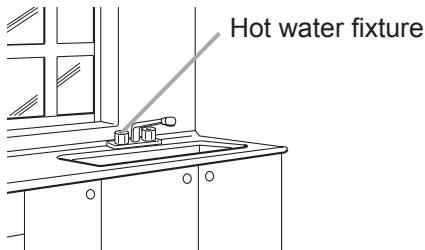

**4** Turn on the power.  
**Do not touch with wet hands.**

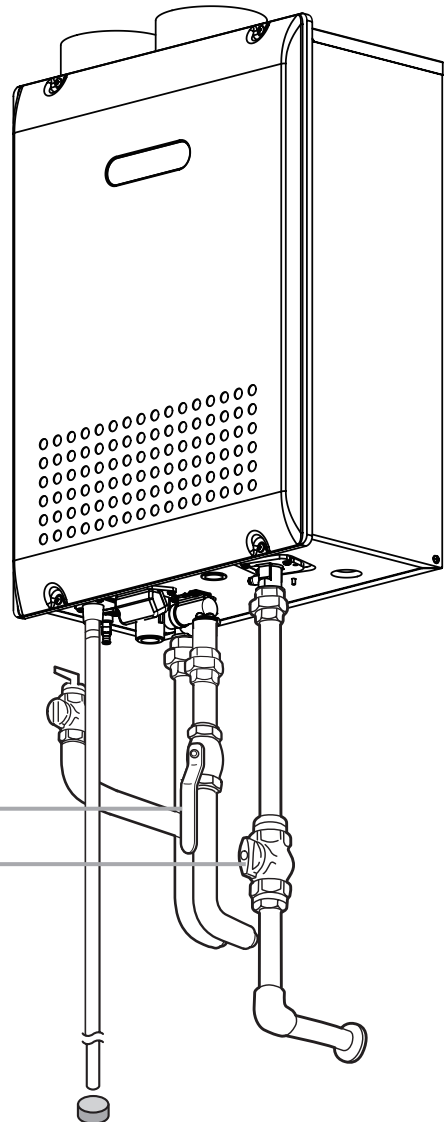

(Ex. NRC98DV (GQ-C2857WS-FF US))

# Setting and Using the Water Heater

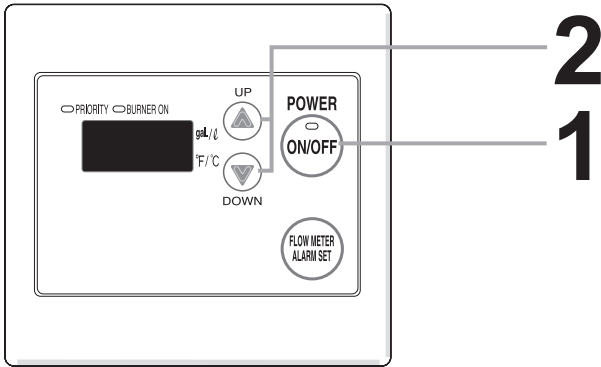

(Starting with the Power Off)

## 1 Press the Power On/Off Button.

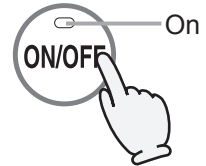

The temperature will be displayed on the remote control thermostat.



Previous set temperature (Ex.: 120°F)

### DANGER



To prevent scalding:  
High Temperature

**Hot Water Heater temperatures over 125°F (52°C) can cause severe burns instantly or death from scalding.**

- Children, disabled and elderly are at the highest risk of being scalded. Feel water temperature before bathing or showering. Temperature limiting valves are available, ask professional person.
- When setting the unit to 125°F / 55°C (131°F) or higher, the temperature display will flash for 10 seconds and emit a tone as a high temperature warning.
- Take caution when using the unit again after setting to 125°F (52°C) or higher. Always check the set temperature before use.
- Do not allow anyone to change the water temperature while hot water is running.

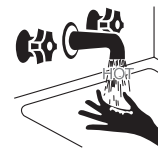

### Remote controller Display



Flashes for 10 sec



## 2 Set temperature.

(Always check the temperature setting before use.)

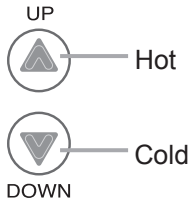

Check the indicator lights.



Water temperature



## 3 Turn on hot water.



## 4 Turn off the hot water.



### ■ When using °F mode:

(°F: The temperature settings below are examples. The temperature setting necessary depends on the usage, the length of piping and the time of year.)

The maximum output temperature can be set using the remote controller. (page 17)

<b>115</b>	<b>120</b>	<b>125</b>	<b>130</b>	<b>135</b>	<b>140</b>
Shower, hot water supply, etc.		High temperature			

\*Initial factory setting is 115°F

### ■ When using °C mode:

(°C (°F): The temperature settings below are examples. The temperature setting necessary depends on the usage, the length of piping and the time of year.)

The maximum output temperature can be set using the remote controller. (page 17)

<b>46</b> (115)	<b>47</b> (117)	<b>48</b> (118)	<b>50</b> (122)	<b>55</b> (131)	<b>60</b> (140)
Shower, hot water supply, etc.				High temperature	

\*Initial factory setting is 46°C (115°F)

If fixtures incorporate mixing valves, set the temperature higher than usual.

- \* For most residential applications, the recommended setting temperature is 120°F / 50°C (122°F) or less.
- \* Consult local codes for minimum operating temperatures.

Note : An error code will be displayed when this water heater detects scale build-up in the heat exchanger. The error code may be more frequently displayed when the unit is set to a high temperature. (125°F or higher) Noritz recommends that water temperature is set as low as possible to prevent scale build-up in the heat exchanger.

## How to Use

# Flow Meter Alarm

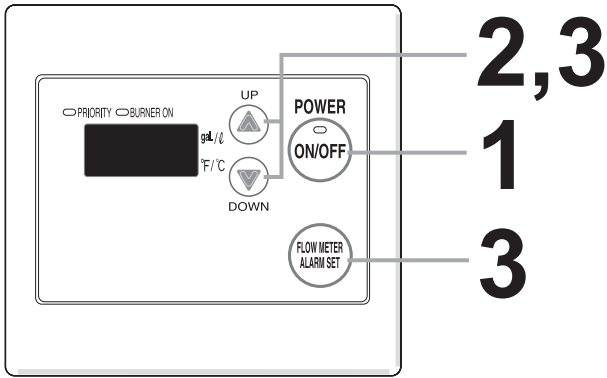

If the flow meter alarm is being used to indicate when a tub is full:

- If any hot water is being used besides what is going into the tub, the alarm will sound before the tub is full.
- If there was water in the tub before the fill began, or if the water is not shut off manually when the alarm sounds, the tub may overflow.
- If there was water in the tub before the fill began, the temperature in the tub after it is full may be different from the temperature setting.

(Starting with the power off)

### Preparation

Plug the bath drain.

## 1 Press the Power On/Off Button

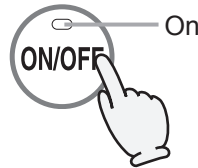

The temperature will be displayed on the remote control thermostat.



Previous set temperature (example: 115°F)

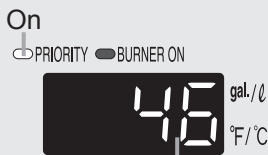

Previous set temperature (example: 46°C)

## 2 Set temperature. (Always check temperature setting before use.)

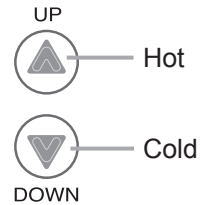

Check the indicator lights.



Water temperature

Check the indicator lights.

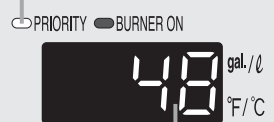

Water temperature

When the display setting is in Fahrenheit.

When the display setting is in Celsius.

An alarm will sound for ten seconds when the flow reaches the set level.



The water will continue to run unless it is manually turned off.

## Water Temperature

(°F) : The temperatures settings below are only examples. The temperature setting necessary will depend on the usage, the length of piping and the time of year.

115	120
Hot	

(°C (°F)) : The temperatures settings below are only examples. The temperature setting necessary will depend on the usage, the length of piping and the time of year.

46 (115)	47 (117)	48 (118)
Hot		

\* Initial factory setting: 115°F or 46°C (115°F)

To set the flow meter alarm:

### 3 Adjust flow meter alarm setting.

Press the flow meter alarm set button (the setting will flash on the display) and adjust with the setting buttons.

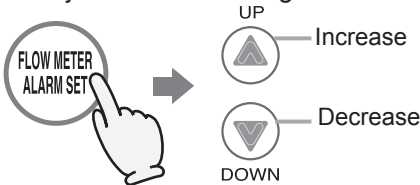

Choose the flow meter alarm setting from the following options: 10 - 60 gallon (40 - 240L) (In 5 gallon (20L) intervals), 70 gallon (260L), 80 gallon (300L), 90 gallon (340L), 100 gallon (380L), 990 gallon.

Note: The alarm will not sound if it is set for 990 gallon.

PRIORITY  BURNER ON



Flow meter setting will be flashing (ex. 45 gallon)

PRIORITY  BURNER ON



Flow meter setting will be flashing (ex. 180L)

- \* The level can only be adjusted while the indicator is flashing.
- \* After ten seconds, the remote will again display the temperature.

### 4 Turn on hot water.

On  
 PRIORITY  BURNER ON



On  
 PRIORITY  BURNER ON



### 5 Turn off the hot water when the alarm sounds.

The alarm will sound when the set level has been reached. Stop the water.

Note: The alarm will not sound if it is set for 990 gallon.

Off  
 PRIORITY  BURNER ON



Off  
 PRIORITY  BURNER ON



# Muting the Remote Controller

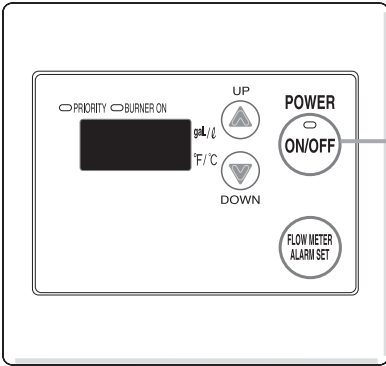

The remote controller will emit a sound when any button is pushed. This sound can be muted if it is desired.

\* Initial factory setting is with sound

## 1 Hold the Power On/Off Button for five seconds.

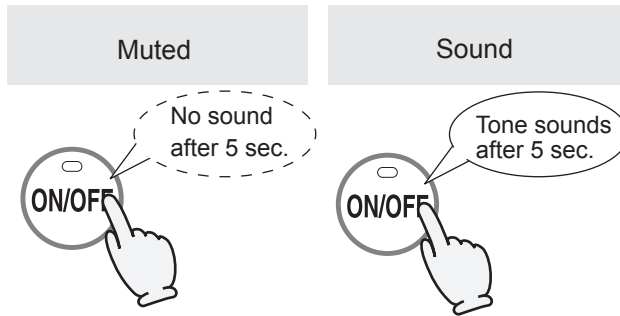

- The flow meter alarm cannot be muted.
- The high temperature warning tone when setting the unit to 125°F / 55°C (131°F) or higher will not emit a sound when muted.



# Adjusting the Maximum Output Temperature

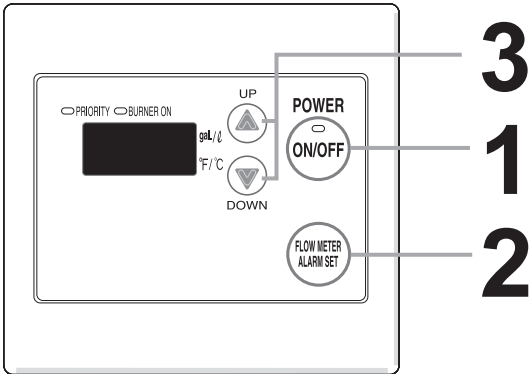

**1** Turn off the power.

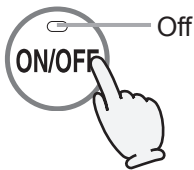

**2** Press and hold the flow meter alarm set button until a sound is heard (2 sec.).

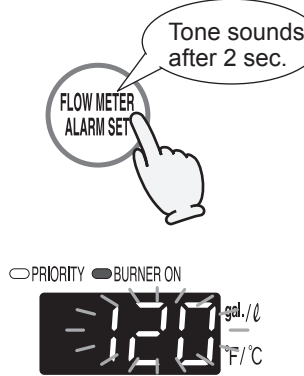

**3** Change the temperature using the setting buttons.

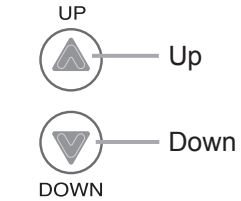

The upper limit of the hot-water supply temperature can be changed to

(For Fahrenheit (°F))  
115°F, 120°F, 125°F, 130°F,  
135°F or 140°F.

(For Celsius (°C))  
46°C, 47°C, 48°C, 50°C, 55°C  
or 60°C.

**4** Set the Power button to ON when continuing to use the unit as is. Otherwise, let the unit sit for 30 sec.

# Preventing Damage from Freezing-1

## CAUTION

- \* Damage can occur from frozen water within the device and pipes even in warm environments. Be sure to read below for appropriate measures.
- \* Repairs for damage caused by freezing are not covered by the warranty.

**Freezing is prevented within the device automatically by the freeze-prevention heater.**

**Freezing cannot be prevented when the power plug is unplugged. Do not remove the power plug from the wall outlet.**

Freezing will be prevented regardless of whether the operation switch is ON or OFF.

- \* In normal operation, freezing is prevented within the device automatically unless the outside temperature without wind is below  $-30^{\circ}\text{F}$  ( $-35^{\circ}\text{C}$ ) for NRC98DV (GQ-C2857WS-FF US) or  $-4^{\circ}\text{F}$  ( $-20^{\circ}\text{C}$ ) for NRC98OD (GQ-C2857WS US).
  - For models NRC98DV (GQ-C2857WS-FF US), when supplying combustion air from the indoors, the room temperature must be greater than  $32^{\circ}\text{F}$  ( $0^{\circ}\text{C}$ ) to prevent freezing and the room inside must not have negative pressure.
- \* The freeze prevention heaters will not prevent the plumbing external to the unit from freezing. Protect this plumbing with insulation, heat tape or electric heaters, solenoids, or pipe covers. If there remains a freezing risk, contact the nearest Noritz agent.

**Take the measures below for extremely cold temperatures\*.**

Outside temperature including wind chill factor less than  $-30^{\circ}\text{F}$  ( $-35^{\circ}\text{C}$ ) for NRC98DV (GQ-C2857WS-FF US) or  $-4^{\circ}\text{F}$  ( $-20^{\circ}\text{C}$ ) for NRC98OD (GQ-C2857WS US).

- For models NRC98DV (GQ-C2857WS-FF US), when supplying combustion air from the indoors, the room temperature must be greater than  $32^{\circ}\text{F}$  ( $0^{\circ}\text{C}$ ) to prevent freezing and the room inside must not have negative pressure.

This method can protect not only the heater, but also the water supply, water piping and mixing valves.

1. Turn off the power.
2. Close the gas supply valve.
3. Open a hot water fixture, and keep a small stream of hot water running. (0.1 gallon (400cc)/minute or about 0.2" (4mm) thick.)

\* If there is a mixing valve, set it to the highest level.

\* When linking multiple units, discharge water equivalent to (0.1 gallon (400cc)/minute per unit.)

4. The flow may become unstable from time to time.

Check the flow 30 minutes later.

\* In general, it is not advisable to run water through the unit when it is OFF ( p. 6), but in this case freeze prevention is more important.

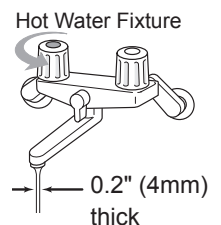

\* Remember to set mixing valves and fixtures to their original levels before using the unit again to prevent scalding.

\* If there is still a risk that the unit will freeze, drain the unit as shown on the next page.

## If water will not flow because it is frozen

1. Close the gas and water valves.
2. Turn off the power button.
3. Open the water supply valve from time to time to check whether water is running.
4. When the water is flowing again, check for water leaks from the equipment and piping before using.

If the heater or the piping is frozen, do not use the heater or it may get damaged.

# Preventing Damage from Freezing-2

**If the water heater will not be used for a long period of time,  
Drain the water.**

Drain the water as follows:

## CAUTION



High Temperature

To avoid burns, wait until the equipment cools down before draining the water. The appliance will remain hot after it is turned off.

To prevent damage from freezing, the water heater must be plugged into power at all times. If power is unplugged, drain the water completely from the water heater. Then use an air compressor to remove all water from inside the unit's water piping. It is recommended that Isolation Valves are installed on the water heater, otherwise the water connections will need to be removed to drain the unit completely. Freeze damage due to not draining properly will not be covered under warranty.

Drain water into a bucket to prevent water damage.

1. Close the gas valve.

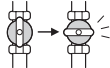

2. Turn off the power button.

3. Turn off the power supply.

**Do not touch with wet hands.**

4. Close the water supply valve.

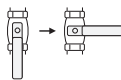

5. Fully open all hot water fixtures.



6. Turn the drain plug to the left to open, and then remove.

7. Check that the water is completely drained, close all the drain plugs and the hot water fixtures after 10 minutes or more pass from operation of 6.

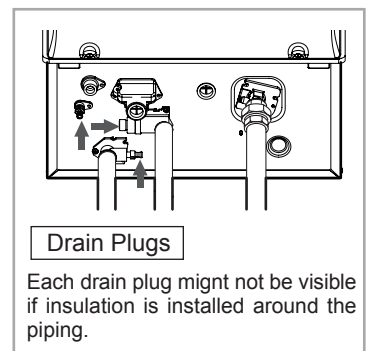

# Preventing Damage from Freezing-3

## Turning the Unit Back On

1. Check that all drain plugs are inserted.
2. Check that all hot water fixtures are closed.
3. Follow the procedure on p.11 "Initial operation", steps 1 through 4.
4. Make sure that the area around the appliance is well ventilated; open a window or a door if necessary. Then, operate the unit and verify that condensate is coming out of the drain pipe.  
(During normal use of the water heater, condensate will begin to discharge from the drain pipe within 15 minutes of use. However, depending on the season and/or installation site conditions, it may take longer.)

\* If water does not appear at the end of the drain line, a qualified service technician must clean the condensate line.

### **DANGER**



Be sure to do.

After the water heater has been out of use for a long time make sure that you fill the condensate trap with water.

This is to prevent dangerous exhaust gases from entering the building.

Failure to fill the condensate trap could result in severe personal injury or death.  
(By performing step 4 as described above, the condensate trap will automatically fill itself with water.)

# Regular Maintenance-1

## Periodic Inspection

### CAUTION

 Be sure to do.

To prevent burns or scalding, turn off the power button and wait until the equipment cools before performing maintenance.

[When supplying combustion air from the indoors]

**Check** For smear or blockage with dust, oil, etc. at the air supply vent. If blocked, remove the build-up with a vacuum cleaner or damp towel.

\* Do not permanently remove the Inlet Screen.

**Check** For laundry, newspaper, timber, oil, spray cans and other combustible materials. near the heater or the exhaust vent terminal.

**Check** For water leaks from the equipment and piping.

**Check** For blockage at the drain pipe discharge.

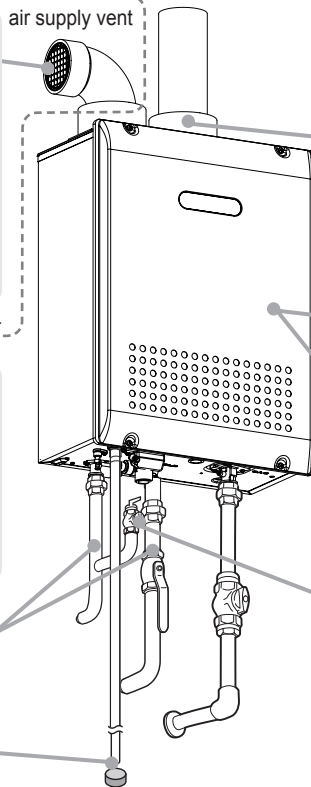

**Check** For dust and soot in the exhaust vent or exhaust vent terminal.

**Check** For abnormal sounds during operation.

**Check** For abnormalities in external appearance, discoloration or flaws.

**Check** For proper operation of pressure relief valve.

(Ex. NRC98DV (GQ-C2857WS-FF US))

## Periodic Maintenance

### Equipment

Wipe the outside surface with a wet cloth, then dry the surface. Use a neutral detergent to clean any stains. If an external condensate neutralizer is installed, periodic replacement of the neutralizing agent will be required. Refer to the instructions supplied with the neutralizer for suggested replacement intervals.

### Remote Controller

Wipe the surface with a wet cloth.

- Do not use benzene, oil or fatty detergents to clean the remote controller; deformation may occur.
- The remote controller is water resistant but not water proof. Keep it as dry as possible.

# Regular Maintenance-2

## Periodic Maintenance

### Water Drain Valve (with Water Filter)

If the water drain valve (with water filter) is covered with debris, the hot water may not run smoothly, or the unit may put out cold water. Check and clean the filter as explained below.

\* **To avoid burns, wait until the equipment cools down before draining the water.**

**The appliance will remain hot after it is turned off.**

1. Close the water supply valve.
2. Open all hot water fixtures.
3. With a bucket ready, remove the inlet and outlet drain plugs (about 0.4 gallon (1.4L) will drain out)
4. Take the water drain valve (with water filter) out of the inlet. (See illustration to right).
5. Clean the water drain valve (with water filter) with a brush under running water.
6. Replace the water drain valve (with water filter) and close the drain plugs.  
(Take care not to lose the packing.)
7. Close all hot water fixtures.
8. Open the water supply valve and check that water does not leak from the drain plugs or water drain valve (with water filter).

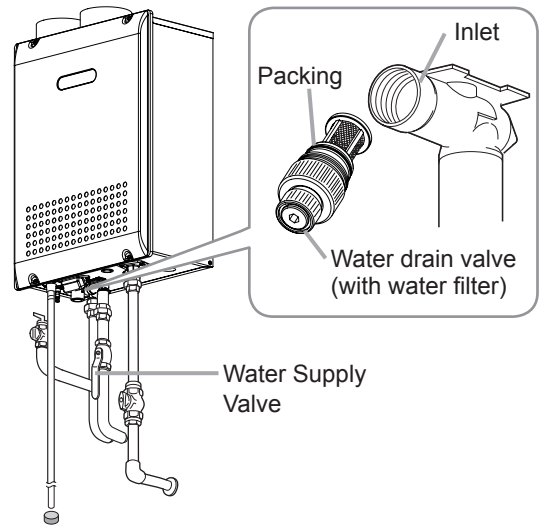

(Ex. NRC98DV (GQ-C2857WS-FF US))

# Water Quality and Maintenance

For people who live in a hard water area, periodical flushing is necessary. If the Heat Exchanger is not flushed, the Scale Build-up may cause damage to the Heat Exchanger. In this case, this water heater will detect the Scale Build-up in the Heat Exchanger and then the error code "C\*#" will be displayed on the Remote Controller.

When the error code "C\*#" is flashing on the Remote Controller, the Heat Exchanger needs to be flushed to prevent damage from Scale Build-up. Please contact Noritz America for more information about flushing the Heat Exchanger. (<http://support.noritz.com/> or 866-766-7489)

\* \* = 1, 2, 3, 4, F

# = 0, 1, 2, 3, 4, 5, 6, 7, 8, 9

Damage to the water heater as a result of below is not covered by the Noritz America Limited Warranty. To ensure full warranty coverage, treat or condition water that exceeds the target levels provided in this table.

- Hard water
- Poor water quality (See the below list.)
- The water heater has displayed a "C\*#" error code indicating Scale Build-up, but the heat exchanger has not been flushed.

Total Hardness**	: 200 mg/L (12 gpg) or less
Aluminum	: 0.05 to 0.2 mg/L or less
Chloride	: 250 mg/L or less
Copper	: 1 mg/L or less
Iron	: 0.3 mg/L or less
Manganese	: 0.05 mg/L or less
pH	: 6.5 - 8.5
Total Dissolved Solids	: 500 mg/L or less
Zinc	: 5 mg/L or less
Sulfate ion	: 250 mg/L or less
Residual chlorine	: 4 mg/L or less

\*\* Maximum limit suggested by Noritz.

Source: EPA National Secondary Drinking Water Regulations (40 CFR Part 143.3)

## Isolation Valves

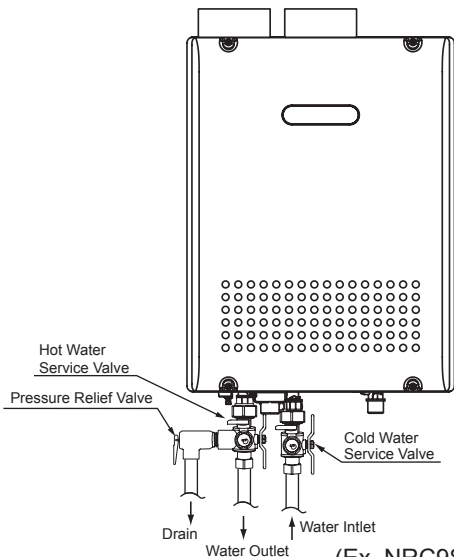

(Ex. NRC98DV (GQ-C2857WS-FF US))

\* Isolation valves may be purchased as an accessory from an authorized Noritz wholesaler. They allow for full diagnostic testing and easy flushing of the system.

\* The kit includes two full port isolation valves and a pressure relief valve for the hot side. Contact Noritz for more information.

# Troubleshooting-1

## Initial Operation

Unit does not attempt to ignite when water is running.	<ul style="list-style-type: none"><li>• Check for reversed plumbing or crossed pipes.</li><li>• Check the water drain valve filter. (☞ p.22)</li></ul>
Unit attempts to ignite but fails	<ul style="list-style-type: none"><li>• Reset unit and try again. There may be air in the gas line.</li><li>• Have a professional check the gas supply pressure.</li></ul>

## Temperature

Hot water is not available when a fixture is opened.	<ul style="list-style-type: none"><li>• Are the gas and water supply valves fully open?</li><li>• Is the water supply cut off?</li><li>• Is the hot water fixture sufficiently open?</li><li>• Is the gas being cut off by the gas meter? (Can other gas devices such as stoves be used?)</li><li>• (For LP) Is there enough gas in the tank? (Can other gas devices such as stoves be used?)</li><li>• Is the water drain valve filter clogged? (☞ p.22)</li><li>• Is the power button turned on?</li></ul>
No water is available when a fixture is opened.	<ul style="list-style-type: none"><li>• Is the water supply cut off?</li><li>• Is the heater frozen?</li></ul>
The hot water is not the correct temperature.	<ul style="list-style-type: none"><li>• Is the hot water fixture sufficiently open?</li></ul>
Water takes time to become hot when turning the hot water fixture.	<ul style="list-style-type: none"><li>• Have you allowed enough time for the cold water in the pipes to drain out?</li></ul>
The water is too hot.	<ul style="list-style-type: none"><li>• Are the gas and water supply valves fully open?</li><li>• Is the water temperature setting appropriate? (☞ p.12 and p.13)</li><li>• If the water supply temperature is high, it is possible for the temperature to be higher than the temperature set on the remote controller.</li><li>• If only a small amount of hot water is demanded, it is possible for the temperature to be higher than the temperature set on the remote controller.</li></ul>
The water is not hot enough.	<ul style="list-style-type: none"><li>• Are the gas and water supply valves fully open?</li><li>• Is the water temperature setting appropriate? (☞ p.12 and p.13)</li><li>• If the amount of hot water required is very high, it is possible for the temperature to be lower than the temperature set on the remote controller. Decrease the amount of hot water passing through the unit and the temperature should stabilize.</li></ul>



(Continued)

The water is cold when only a single fixture is open.	<ul style="list-style-type: none"><li>• The unit will not heat the water if the flow rate is less than 0.5 gallons (2L) per minute. Open the fixture more or open other fixtures so that a greater flow passes through the unit, and the unit should begin heating again.</li></ul>
Fluctuations in hot water temperatures.	<ul style="list-style-type: none"><li>• Set water temperature at 115°F to 120°F or 48°C (118°F) to 50°C (122°F). This will allow you to use a higher flow of hot water thus meeting the minimum flow requirement of 0.5 GPM (2L/min.).</li><li>• Clean the water filter of any debris (👉 p.22)</li></ul>
Setting temperature cannot rise.	<ul style="list-style-type: none"><li>• Is the maximum temperature setting appropriate? (👉 p.17)</li></ul>

## Amount of Hot Water

The amount of hot water at a certain fixture is not constant.	<ul style="list-style-type: none"><li>• When hot water is demanded at other fixtures, the amount available may be reduced. The maximum flow available from this unit is 7.5 GPM (28.2L/min.) at a 45°F (25°C) temperature rise.</li><li>• Pressure fluctuations and other plumbing conditions can cause the temperature and pressure at a fixture to be unstable, but it should stabilize after a short time.</li><li>• There are some types of hot water taps that discharges large volumes of hot water at first but stabilize after time.</li><li>• To keep the temperature stable, the heater limits the amount of water that can flow through it to a small amount initially, but the amount increases over time.</li></ul>
The amount of hot water in the tub is less/more than the set amount.	<ul style="list-style-type: none"><li>• When hot water is used for other fixtures while filling the bath tub, the tub will not fill as much.</li><li>• If there is water in the tub already, or when filling is stopped and restarted, the tub will fill more.</li></ul>
The flow meter alarm does not sound even when filled to the set amount.	<ul style="list-style-type: none"><li>• The flow meter alarm is set to sound when hot water is continuously discharged for the set volume of water. If mixing valves are used, or if cold water is mixed with hot water at the fixture, the tub will fill more than the setting of the flow meter alarm.</li></ul>
Amount of hot water available has decreased over time.	<ul style="list-style-type: none"><li>• Is the water filter clogged? (👉 p.22)</li><li>• If the supply water is hard and has not been treated, scale can build-up in the water heater and decrease the maximum amount of hot water available. Scale can be removed from the water heater by flushing the unit periodically. To prevent scale from forming in the water heater, a water softener or scale inhibitor is recommended.</li></ul>

# Troubleshooting-2

## Remote Controller

The light on the power button does not come on.	<ul style="list-style-type: none"><li>• Has there been a power failure?</li><li>• Is the power connected properly?</li></ul>
The water temperature changes after a power failure or when the power is disconnected.	<ul style="list-style-type: none"><li>• The temperature setting and the flow meter alarm setting may both need to be reset after a power outage.</li></ul>
The plastic on the surface or buttons of the remote controller has torn, peeled, or air bubbles inside.	<ul style="list-style-type: none"><li>• The surface of the remote controller is affixed with a protective sheet (to prevent surface scratching, etc.) at time of shipment. This sheet can be removed or left as it is. When leaving the protective sheet on, areas frequently touched may tear or peel. However, the remote controller will not malfunction from water entering such torn or peeled areas. To restore the appearance of the remote controller surface, simply remove the protective sheet.</li></ul>

## Sounds

The fan can be heard after operation is stopped. A motor can be heard when turning the unit ON or OFF, when opening or closing a fixture, or after the unit has been running for a while.	<ul style="list-style-type: none"><li>• These noises indicate the proper operation of devices which are designed to let the unit reignite more quickly, and ensure the water temperature is stable.</li></ul>
The fan can be heard when it is very cold outside.	<ul style="list-style-type: none"><li>• The fan may run to prevent freezing.</li></ul>

## Other

The Heater stops burning during operation.	<ul style="list-style-type: none"><li>• Are the gas and water supply valves fully open?</li><li>• Is the water supply cut off?</li><li>• Is the hot water fixture sufficiently open?</li><li>• Is the gas being cut off by the gas meter? (Can other gas devices such as stoves be used?)</li><li>• (For LP) Is there enough gas in the tank? (Can other gas devices such as stoves be used?)</li></ul>
White smoke comes out of the exhaust vent on a cold day.	<ul style="list-style-type: none"><li>• This is normal. The white smoke is actually steam.</li></ul>
The hot water is turbid.	<ul style="list-style-type: none"><li>• This is harmless. Small bubbles appear as the air in the water is heated and depressurized rapidly to atmospheric pressure.</li></ul>

(Continued)

(Continued)

<p>The water appears blue The bath tub/wash-basin has turned blue</p>	<ul style="list-style-type: none"><li>• Coloration to a blue color may be noticed from small traces of copper ion contained in the water and fat (furring). However, there are not problems concerning health. Coloration of the bath tub/wash-basin can be prevented by cleaning frequently.</li></ul>
<p>Frequent water discharge from the drain pipe.</p>	<ul style="list-style-type: none"><li>• Condensation forms inside the unit during operation and is discharged from the drain pipe.</li></ul>

# Troubleshooting-3

## Check for an Error Code on the Remote Controller

If there is a problem with the unit, a numerical error code will flash on the remote controller. If this occurs, take appropriate measures as listed below.

When an error code appears, the display and the operation light will flash together.

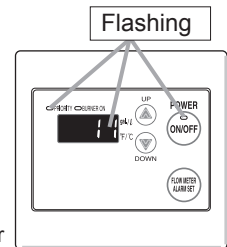

Remote Controller

Error Code	Cause	Action
11	Ignition error	Check whether the gas valve is open. Press the power button to turn the unit off, open a hot water fixture, and turn the unit back on. If the flashing number doesn't return the problem is solved.
29	Clogging of condensate trap or drain pipe	Check to see if the condensate drain pipe is clogged or frozen ( p.8) Contact the installer or Noritz America Technical Support for assistance.
90	[When supplying combustion air from the indoors] The air supply vent may be clogged.	Clean the air supply vent.( p.21) If the display continues, contact the nearest Noritz agent.
	Abnormal combustion, low gas supply pressure	Have a professional check the gas supply pressure. Contact the nearest Noritz agent.
99	Abnormal combustion	Contact the nearest Noritz agent.
C*# *=-1-4, F #=0-9	The unit detects Scale Build-up in the Heat Exchanger. (Warning indication, and then the unit will shut off before long.)	The unit may shut off and lock before long. Needs to be flushed the Heat Exchanger to remove the Scale Build-up. If the unit will shut off and locked for this error, the unit can temporarily operate by disconnecting electrical power until the Heat Exchanger can be flushed. Contact Noritz America for more information about flushing the Heat Exchanger. (866-766-7489)
CF# #=0-9	The unit detects the Scale Build-up in the Heat Exchanger many times (The unit is locked.)	The unit is locked because of repeated Scale Build-up error codes. Must flush the Heat Exchanger to remove the Scale Build-up. Before flushing the Heat Exchanger, contact Noritz America for more information.(866-766-7489)

### Contact Noritz America if:

- Any other error code appears.
- An error code is indicated again after the above actions were followed.
- There are any other questions.

# Follow-up Service-1

## Requesting Service

First follow the instructions in the troubleshooting section ( p.24 to p.28).  
If the error is not corrected, contact Noritz America Technical Support at 866-766-7489.

We will need to know:

**The Model** .....(check the rating plate)

\*See p.4 for the location of the label

**Date of purchase** .....(see the warranty)

**Details of problem** ....(flashing error codes,  
etc., in much detail as possible)

**Your name, address, and telephone number**

**Desired date of visit**



\* A request for service may be rejected if the water heater is installed in a location where working on the unit may be dangerous. Contact a plumber.

## Warranty

A warranty registration card is included separately.

Be sure that the plumber, date of purchase and other necessary items are filled in.

Read the content carefully, and keep the warranty card in a safe place.

For repairs after the warranty period, there will be a charge on any service, and service will only be performed if the unit is deemed repairable.

## Period of Time for Stocking Repair Parts

Noritz will stock repair and maintenance parts for this unit for the time period from the date of the original installation as follows: twelve (12) years for the heat exchanger and ten (10) years for remaining parts.

## Reinstallation

If you want to reinstall the appliance at a different location, confirm that the gas and power supply indicated on the rating plate are available at the new location. If you are not sure, consult the local utility company.

# Follow-up Service-2

## Gas Conversion

If you move to a region that uses a different type of gas or if the local gas supply is converted, replacement of the gas manifold and adjustment of the appliance will be necessary. This work must be performed by either Noritz or a qualified service agency and will be charged for even during the warranty period. The qualified installer will also be responsible for purchasing the gas conversion kit directly from the manufacturer.

For more information, contact Noritz America Technical Support at 866-766-7489.



The gas conversion kit shall be installed by a qualified service agency\* in accordance with the manufacturer's instructions and all applicable codes and requirements of the authority having jurisdiction. The information in the instructions must be followed to minimize the risk of fire or explosion or to prevent property damage, personal injury, or death. The qualified service agency is responsible for the proper installation of this kit. The installation is not proper and complete until the operation of the converted appliance is checked as specified in the manufacturer's instructions supplied with the kit.

\* A qualified service agency is any individual, firm, corporation, or company which either in person or through a representative is engaged in and is responsible for the connection, utilization, repair or servicing of gas utilization equipment or accessories; who is experienced in such work, familiar with all precautions required, and has complied with all of the requirements of the authority having jurisdiction.

Before the gas conversion is performed, verify the proper gas conversion kit with your water heater model on the table provided below.

Conversion Kit	Model	Conversion Type
CK-31	NRC98DV (GQ-C2857WS-FF US)	Propane to Natural Gas
CK-32	NRC98DV (GQ-C2857WS-FF US)	Natural Gas to Propane
CK-33	NRC98OD (GQ-C2857WS US)	Propane to Natural Gas
CK-34	NRC98OD (GQ-C2857WS US)	Natural Gas to Propane

The following parts are supplied in the conversion kit. These items will replace the existing parts that are currently installed in the unit. Make sure that all parts are replaced and properly installed by a qualified service agency.

\* A Noritz remote controller and a digital gas manometer are required to complete the installation. Do not proceed if this equipment is not immediately available.

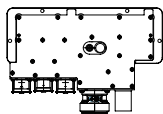

Manifold Plate



O-Ring

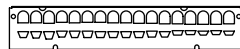

Damper



Conversion Kit Label

After the necessary parts have been replaced on the unit, the remote controller is then used to adjust the settings on the water heater for use with the proper gas type.

The gas pressure values at both the gas supply inlet fitting and at the manifold inlet on the unit are verified by the installer. Proper adjustments will be made to ensure safe and efficient operation.

Once this is completed, a final gas leak check will be performed to confirm that all parts have been securely installed.

If you notice the smell of gas at any time after the installation has been completed, turn the water heater off and contact your gas supplier immediately.

# Specifications

- Specifications may be changed without prior notice.
- The capacity may differ slightly, depending on the water pressure, water supply, piping conditions, and water temperature.

## Specifications

Item		Specification	
Model Name		NRC98DV (GQ-C2857WS-FF US)	NRC980D (GQ-C2857WS US)
Type	Installation	Indoor Wall Mounted	Outdoor Wall Mounted
	Air Supply/Exhaust	Power Vented	
Ignition		Direct Ignition	
Operating Pressure		15-150 psi	
Minimum Flow Rate		0.5 GPM (2 L/min.)	
Dimensions (Height) x (Width) x (Depth)		24.2" (615mm) x 18.3" (464mm) x 9.4" (240mm)	
Weight		58 lbs.	57 lbs.
Water Holding Capacity		0.5 Gallon (1.8L)	
Connection Sizes	Water Inlet	3/4"	
	Hot Water Outlet	3/4"	
	Gas Inlet	3/4"	
	Condensate Drain	1/2" Threaded	
Power Supply	Supply	120 VAC (60Hz)	
	Consumption	NG : 73W LP : 78W Freeze Prevention 213W	NG : 64W LP : 68W Freeze Prevention 203W
Materials	Casing	Zincified Steel Plate/Polyester Coating	
	Flue Collar	PVC	Stainless Steel
	Primary Heat Exchanger	Copper Sheeting, Copper Tubing	
	Secondary Heat Exchanger	Stainless Steel Sheeting, Stainless Steel Tubing	
Safety Devices		Flame Rod, Thermal Fuse, Lightning Protection Device (ZNR), Overheat Prevention Device, Freezing Prevention Device, Fan Rotation Detector	
Accessories		Remote Controller, Remote Controller Cord, Anchoring Screws	

## Performance

Item		Maximum Performance	Minimum Performance
Gas Consumption	NG	180,000 btuh	16,000 btuh
	LP	180,000 btuh	16,000 btuh
Maximum Hot Water Capacity	45°F (25°C) Rise	7.5 GPM (28.2 L/min.)	
Capacity Range		0.5-9.8 GPM (2-37.0 L/min.)	
Temperature Settings	°F Mode:	115-140°F (In 5°F intervals) (6 Options)	
	°C Mode:	46,47,48,50,55,60°C (6 Options)	
Default Temperature Options		120°F (50°C), 125°F (52°C), 130°F (54°C), 140°F (60°C) (Original is 120°F (50°C))	

